

SERIES: YHY-DS120 | **DESCRIPTION:** AC-DC POWER ADAPTER



FEATURES

- Level VI efficiency
- 120W power
- Universal input (100~240 Vac)
- Single regulated outputs
- Over voltage and short circuit protections
- Power Factor connection
- Custom designs available
- Certified to 62368-1 standards

APPLICATIONS

- IT Equipment
- Audio Equipment
- Office Equipment
- Energy Storage
- Massage Devices
- Sports Equipment
- Supermarket Applications

Part Number	Model	Output Voltage (Vdc)	Output Current (Amp)	Output Power (Watt)	Ripple & Noise (mVp-p)	Efficiency Level
DSXXXXYYAA-BB-NN (Notes As below)	YHY-09010000	9	10	90	100	VI
	YHY-12010000	12	10	120	120	VI
	YHY-15008000	15	8	120	150	VI
	YHY-18006600	18	6.6	120	200	VI
	YHY-20006000	20	6	120	200	VI
	YHY-24005000	24	5	120	240	VI
	YHY-30004000	30	4	120	300	VI

Notes: 1. At full load, nominal input 100-240Vac, 20 MHz bandwidth oscilloscope, each output terminated with 0.1 μF multilayer ceramic and 10 μF low ESR electrolytic capacitors.

PART NUMBER

DSXXXYYYAA-BB-NN

xxx:	YYY:	AA:	BB:	NN:
Output Voltage	Power	Input Inlet C6/C8/C14/ST/T	DC Connector	A/E/H/S/D/XW...
9Vdc=090	120W=120	IEC320C14=C14	Barrel=N/A 4Pin=4P	

INPUT

Paramater	Description	Min.	Typ	Max.	Units
Input Voltage		90		264	Vac
Rated Voltage		100		240	Vac
Input Frequency		47		63	Hz
Rated Frequency		50		60	Hz
Current				2.5	A
Inrush Current	110Vac 60Hz, Full load, 25°C			40	A
	220Vac 50Hz, Full load, 25°C			80	A
Leakage Current	110Vac / 220Vac			0.05	mA
Power Factor Correction		0.9			
No Load Power Consumption	110Vac / 220Vac			0.21	W
Fuse		5			A

OUTPUT

Paramater	Description	Min.	Typ	Max.	Units
Regulation		±5			%

PROTECTION

Paramater	Description	Min.	Typ	Max.	Units
Over Voltage Protection	Output Shut Down	10			%

Over Current Protatation	Output Shut Down, Auto Recovery	%
Short Circuit Protatation	Output Shut Down, Auto Recovery	%

SAFETY & COMPLIANCE

Paramater	Description	Min.	Typ	Max.	Units
Isolation Voltage	Power Supply of Class I, primary to secondary (AC input grounding connection with the DC output negative terminal) ,3s		1500		Vac
	Power Supply of Class II, primary to secondary, 3s		3000		Vac
Isolation Resistance	500Vdc between Primary Live, Primary Neutral and secondary.	10			MΩ
EMI/EMC	FCC Part 15B Class B, CE				
MTBF	25°C	50,000			Hrs
RoHs	YES				

ENVIRONMENT

Paramater	Description	Min.	Typ	Max.	Units
Operating temperature	Full load, Normal operation	0		40	°C
Storage temperature	With package	-40		85	°C
Operating humidity	Full load , Normal operating	5		95	%
Storage humidity	Non-condensing	10		90	%

MECHANICAL

Paramater	Description	Min.	Typ	Max.	Units
Dimension	175 x 72 x 39				mm
Weight	Without AC Power Cord				g

MECHANICAL DRAWING

Unit: mm

Tolerance: ± 0.2

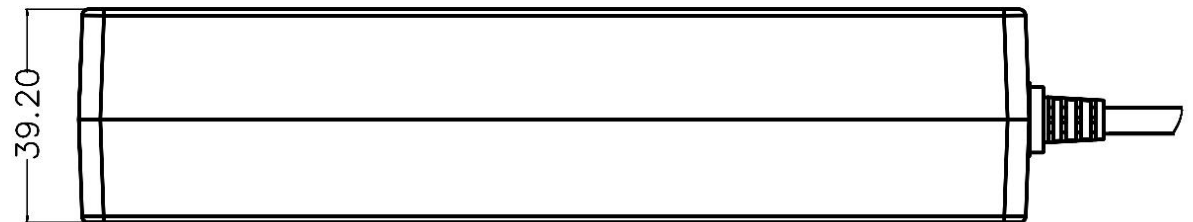
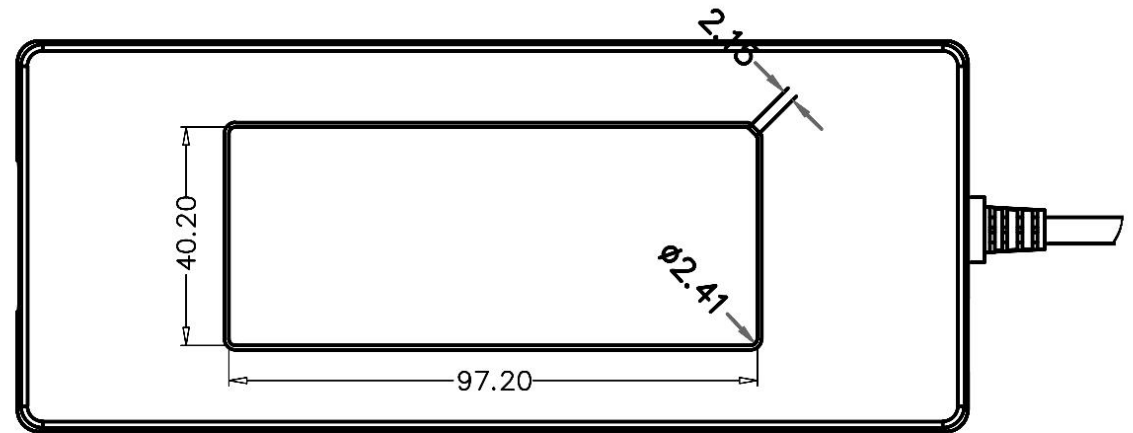
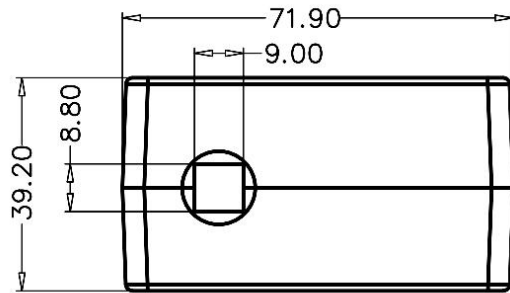
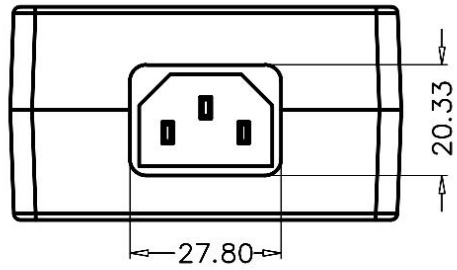

DC CABLE

Unit: mm

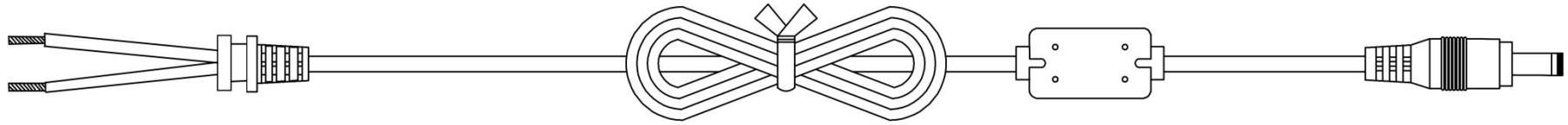

Table 1

Cable	Length
UL2464, 16AWG	1200mm±30
UL2468, 16AWG	1200mm±30
UL1185, 16AWG	1200mm±30

DC CONNECTOR

Plug Polarity

P= Center Positive



N= Center Negative



Plug Polarity		Type	Dimensions (mm)			Plug Angle	
Center Pos.	Center Neg.		A	B	C	Straight	Right
■	■	Barrel	5.5	2.1	10	■	■
■	■		5.5	2.5	10	■	■
■	■		6.5	3.0	10	■	N/A
■	■	Locking	5.5	2.1	9.5	■	N/A
■	■		5.5	2.5	9.5	■	N/A
N/A	N/A	Audio	3.5		14	■	N/A

N/A	N/A	Din	3Pin 4Pin	■	N/A
N/A	N/A	XLR	2P 3P 4P 5P	■	N/A
N/A	N/A	Aviation Connector	GX12: 2P 3P 4P 5P	■	N/A
N/A	N/A	USB	USB Type C	■	N/A
N/A	N/A	Cigarette Lighter	Male	■	N/A
N/A	N/A		Female	■	N/A
N/A	N/A	Stripped & Tinned		N/A	N/A

Barrel

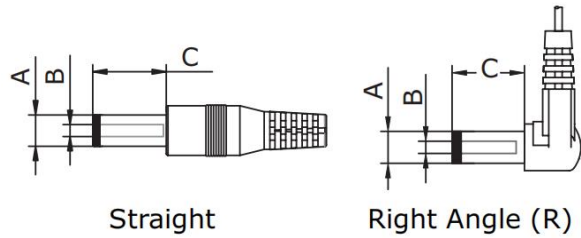

Locking

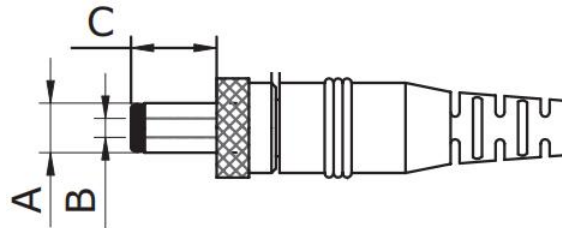

Audio

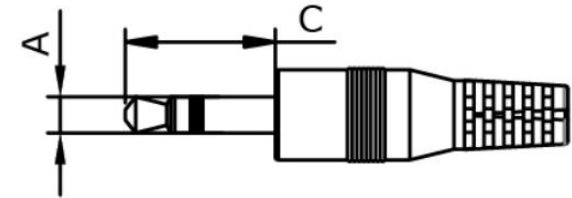

Din

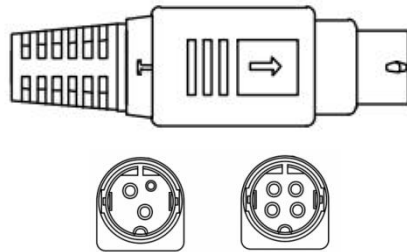

XLR

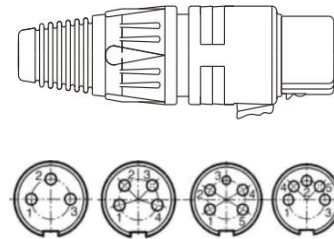

Aviation Connector

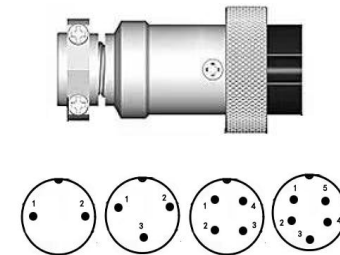

USB Type C

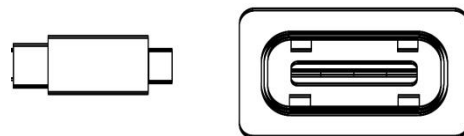

Cigarette Lighter

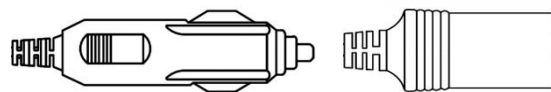

Stripped & Tinned

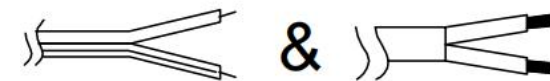

AC Power Cord

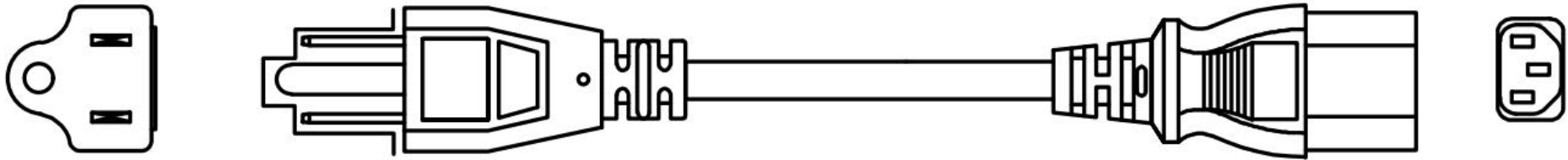
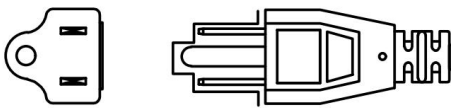

Table 2

AC Power Cord	North America	Europe	United Kingdom	Australia	South Korea	Japan	China	South Africa	Argentina	Italy	Switzerland	Brazil
Length	1200mm ± 30											
Cable Type	3Cx18AWG											
Connector	IEC320-C13											

NORTH AMERICA



EUROPE

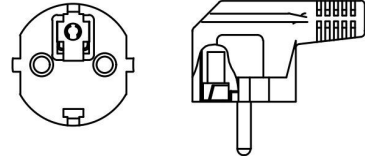

UNITED KINGDOM

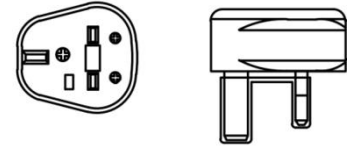

AUSTRALIA



JAPAN

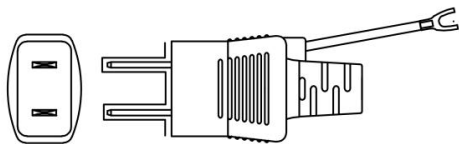

SOUTH KOREA

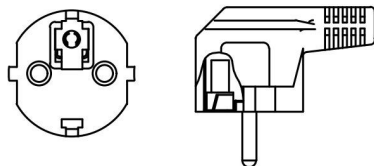

CHINA

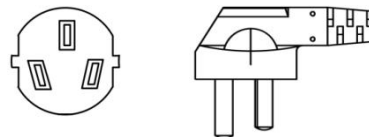

SOUTH AFRICA



ITALY

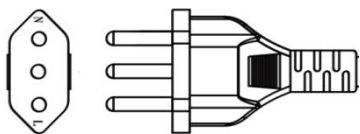

SWITZERLAND

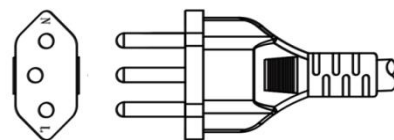

BRAZIL

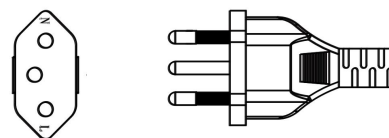

ARGENTINA



REVISION HISTORY

REV.	Description	Date
1.0	Initial release	2025-6-17



YinghuiYuan Electronics (YHYadapter)

3rd BLD, Fuqiao 5th Industry,

Fuyong, Baoan, Shenzhen, CN

518103

<https://yhyadapter.com/>

Email: sales@yhyadapter.com

MB/Whatsapp: +86-13631527465